

GTC4 LUSO

Soccorso Stradale

Electronic alarm	4
Doors	6
Fuel inertia switch	7
Position of battery	8
Battery	9
Luggage compartment lid	11
Engine compartment lid	13
Emergency opening of GTC4Lusso model fuel cap	15
Fuel filler flap and neck	16



1



Starting the vehicle



Electronic alarm

The electronic alarm system performs the following functions:

- remote control for central door locking/unlocking;
- perimeter surveillance, detecting if doors and lids are opened;
- volumetric surveillance, detecting intrusion in the passenger compartment;
- vehicle movement surveillance.

Activation

To turn on the alarm system, press button **F** on the key:

- the turn indicators flash once;
- the system beeps once;
- the red LED on the dashboard flashes;
- the central door locking system of the vehicle is activated and the doors are locked.

The system activates after approximately 25 seconds.

When the electronic alarm is activated, the user may request opening of the luggage compartment; in this case, the motion and anti-lift sensors are temporarily deactivated.

If the luggage compartment is then closed, the sensors will be reactivated.

Warning



If the turn indicators and the red LEDs on the dashboard flash 9 times when the alarm system is activated with doors, rear and front lids properly closed, it means that the self-diagnostic feature has detected a malfunction in the system. Contact the FERRARI SERVICE NETWORK to have the system checked.



If the turn indicators and the red LED on the dashboard flash 9 times when you activate the alarm system, it means that one of the doors or the front/rear lid is open or not closed properly and is therefore not protected by the perimeter surveillance. If this is the case, check that the doors and front/rear lids are closed properly and close any door or lid that is open without deactivating the alarm system: the turn indicators will flash once to indicate that the door or the front/rear lid is now closed properly and is protected by the perimeter surveillance.

Deactivation

To deactivate the alarm system, press button **G** on the key:

- the turn indicators flash twice;
- the system beeps twice;
- the red LED on the dashboard extinguishes;
- the ceiling lights illuminate;
- the central door locking system of the vehicle is deactivated and the doors are unlocked.

Pressing button **G** twice unlocks the doors and also turns on the low beams for 30 seconds. The alarm system is off and you can now get into the vehicle and start the engine.



Important note



To enter the vehicle if the remote control battery is flat, remove the metal bar L and insert the key into one of the two door locks and turn it to release the lock; the alarm siren will start to sound. Start the vehicle following the emergency procedures; The alarm siren will deactivate.

Deactivating the anti-lift alarm

Press button **H** on the roof panel to deactivate the anti-lift alarm system. When this function is deactivated, the indicator light on the button will flash for about 3 seconds and will then turn off.

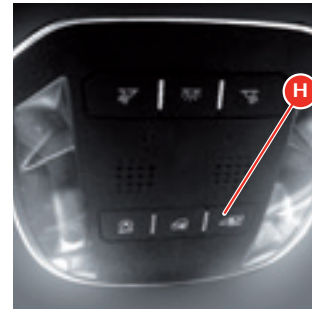

Alarm memory

If, when the vehicle is started, the CODE symbol appears on the left TFT display for 10 seconds after the system diagnosis cycle, together with the message “Break-in attempted”, this means there has been an attempt to break into the car, causing the alarm to activate.

In this case, the system will indicate the reason for the alarm activation according to the following priority:

- LED off two times: lifting sensor alarm
- LED off three times: door alarm
- LED off four times: luggage compartment lid alarm
- LED off five times: ignition key alarm

When the engine is switched on, the alarm system memory is reset.



Homologation

The installed electronic alarm system complies with EU (European Union) regulations on electromagnetic compatibility and it is marked accordingly. For those markets that require the transmitter and/or receiver marking, the homologation number is found on the component.

Doors

When a door is opened or closed, the window automatically moves down by approximately 2 centimetres (to its “target position”) to avoid colliding with the upper weather strip.

When the door is closed, the window automatically moves up until it reaches the “upper limit”.

Opening from the outside

Using the remote control, deactivate the alarm and the central door locking system, or turn the key in the lock to deactivate the central door locking system.

To open the door, pull handle **A**: the window will move down to its “target position”. When the door is closed, the window will move up until it meets the upper limit.



Locking and opening the doors from the inside

Warning



Always carefully check manually that the doors have been closed properly to prevent them from opening while driving.

Both doors can be locked by activating/deactivating the “LOCK/UNLOCK” button **B** on the roof panel. To lock the doors, press button **B**; when the door lock is activated, the light on button **B** comes on. To deactivate the door lock, press button **B** until the light goes out.

The rolling lock function, which automatically locks the doors when the vehicle speed reaches or exceeds 20 km/h, may be activated from the “Car settings” menu accessible from the left TFT display of the instrument panel.

If you pull handle **C** to open the door, the window will move down to its target position. When the door is closed, it will move up until it meets its upper limit.

If handle **C** is lifted without opening the door, the window will move down to its target position and stop and if the door is not opened within 2 seconds, the window will move back up until it meets the upper limit. Therefore, to open the door, release handle **C** and pull it again.

When the opening handle is operated, both doors are unlocked.

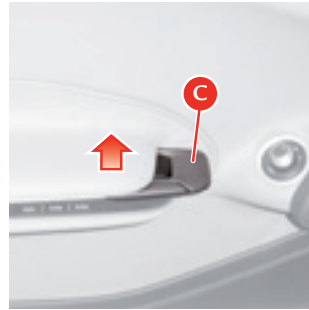

1

Fuel inertia switch

The fuel inertia switch is a safety device which deactivates the fuel pump relays if a collision occurs.

A symbol appears on the left TFT display and the hazard warning lights come on to indicate that the switch has been activated.

When the fuel inertia switch is activated, the doors are also unlocked (if locked) and the central dome light comes on.

Warning



The fuel pump relays can be reactivated by pressing button A on the floor in front of the driver's seat.



Position of battery



To disconnect the power supply from the battery to the electrical system, use the quick release **C** on the left side of the battery. Use the locking lever to loosen the terminal.



Battery

The battery is located on the right-hand side of the engine compartment: to access it, remove the cosmetic shield by unscrewing the two screws shown in the figure.

Checking the battery

Warning



The battery does not need topping up with distilled water or sulphuric acid.

Warning



The battery must only be removed from the vehicle by the Ferrari Service Network. Removal of or damage to the battery affect the vehicle software ECUs and may result in error codes, data loss or inaccurate data.



Warning



Do not place the battery near sources of heat, sparks or naked flames.

The vehicle is equipped with a sealed lead acid battery that does not require maintenance.

- Periodically check that the terminals and pins are clean and firmly secured.
- Visually inspect the outer casing for any cracks.
- If the battery overcharges, it will wear out quickly.
Have the vehicle electrical system checked if the battery tends to discharge easily.

Disconnecting the battery

Before disconnecting the battery, deactivate the electronic alarm using the remote control.

Warning



Never disconnect the battery from the electrical system when the engine is running.

Before disconnecting the battery, lower the side windows by at least 2-3 centimetres to avoid damaging the strips when opening and closing the doors.

Warning



When the battery is connected and charged, this operation is automatically performed when the doors are opened and closed. The windows must remain lowered until the charged battery is reconnected. If the battery is discharged and the windows are fully up, only open the



doors when strictly necessary and take great care; do not close them again until the windows can be lowered.

Important note



We recommend using the battery conditioner if the vehicle is going to left unused for a long period.

To cut off the power supply from the battery to the electrical system, use the quick release C on the left side of the battery. Use the locking lever to loosen the terminal.

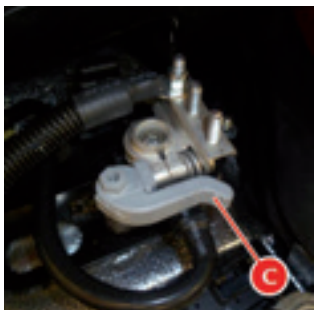

Detach the terminal from the battery: the power supply from the battery to the electrical system is cut off.

Warning



The battery quick release must only be used if the battery conditioner cannot be connected.

Warning



Place the terminal so that it does not come into contact with the battery terminal or other metal parts of the vehicle.

Reconnecting the battery

Place the clamp on the battery and fasten it by closing the locking lever. Each time the battery is reconnected, do the following before starting the engine:

- close both doors and close the luggage compartment lid; unlock and lock the doors using the remote control; open the luggage compartment lid using the remote control.
- adjust the clock (date and time on instrument panel);
- close both doors and fully raise the driver side and passenger side windows to their upper limit; check that the windows move down to the “target position” when the doors are opened.

Warning



Before starting the engine, wait at least 60 seconds after activating the instrument panel to allow the electronic system that controls the motor-driven valves and the AC ECU to run a self-acquisition process. During this period, no devices must be activated.

The Motronic ECU self-acquisition cycle will only function correctly when the intake air temperature is above 5 °C.

After removing the battery from the vehicle or disconnecting it from the electrical system using the battery master switch, it is important to check that the external temperature is within the indicated values when reconnecting before performing the self-acquisition cycle.

Emergency starting

If the battery is flat, you can perform an emergency start by connecting the special jump leads to the battery of another vehicle, a portable jump starter or an external battery.

Important note



Emergency starting can only be performed with batteries with a nominal voltage of 12 V.

Important note



For emergency starting, only use leads that do not allow reverse polarity, with sufficient cross-section and insulated clamps.

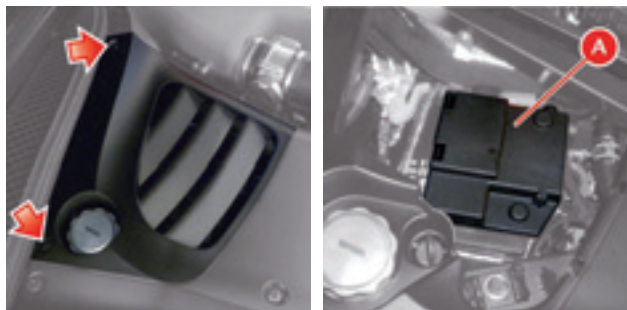

To perform an emergency start, do the following:

- Apply the parking brake;
- Deactivate all the electrical devices;
- Remove the cosmetic shield on the right-hand side of the engine compartment by unscrewing the two screws shown in the figure;

- Remove the cover **A** of the fuse box located above the positive terminal;
- If emergency starting is performed using the battery of another vehicle, let the engine on the other vehicle idle;
- Using the jump leads, connect the positive terminal of the battery to the positive terminal of the portable jump starter or external battery going from the battery on your own vehicle;
- Connect the negative terminal of the portable jump starter or external battery to an earthing point on your vehicle using the jump lead going from the external battery;
- Start the engine;
- Disconnect the jump lead from the earthing point and then from the positive terminal of the battery on your vehicle.

Warning



After emergency starting, go to the nearest Ferrari Service Network immediately to get the battery checked.

Luggage compartment lid

The vehicle is equipped with an electrically operated system for opening and closing the luggage compartment lid.



Opening

The luggage compartment lid can also be opened with the instrument panel deactivated.

Push release button **G** on the driver-side door panel or press button **H** on the ignition key for more than 2 seconds.

The lid is held open by two shock absorbers **L**.

The luggage compartment is illuminated by two lights at the sides that come on automatically when the lid is opened.

Warning



To avoid damage, check there is enough room to open the luggage compartment lid.

Important note



After removing the battery from the vehicle or disconnecting it from the electrical system, a door lock/unlock cycle must be performed using the buttons on the key when reconnecting so that the release

button **G** resumes normal operation (electronic system self-acquisition procedure).

Closing

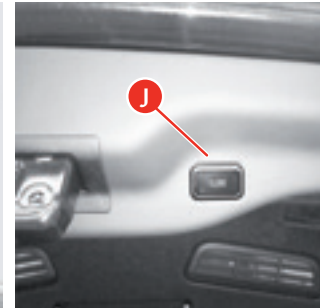

Press the **CLOSE** button **J** on the right-hand side of the luggage compartment to close. Electrically-operated opening and closing can be interrupted at any time by pressing the open and close buttons again.

Warning



Always check manually that the luggage compartment lid has been closed properly to prevent it from opening while driving.

Warning



Never leave children unattended in the vehicle.

Warning



Only open or close the luggage compartment lid when the vehicle is stationary.

Warning



Before opening or closing the luggage compartment lid, make sure there are no people, animals or objects in the immediate vicinity.

Obstacle detection system during opening/closing

If movement of the lid meets resistance because it is blocked by an obstacle, opening/closing stops. If movement is interrupted while opening, the lid stops; if movement is interrupted while closing, the lid reopens. Once the obstacle has been removed, the lid can be closed by pressing button **J**.

Warning



Although the system has a protection mechanism, always make sure that you and other people keep clear of the luggage compartment lid operating area.

Memorising the “Garage Position”

To avoid damaging the lid (when the vehicle is in a garage with a low ceiling, for example), the maximum opening position can be adjusted. To memorise the new position (“Garage Position”), stand near the lid, open it by pressing button **H** on the ignition key and then block it manually in the desired position. Then hold down the **CLOSE** button **J** until the turn indicators start to flash. To adjust the Garage Position again, manually move the lid into the desired position and repeat the procedure.

Once the Garage Position has been memorised, the lid will only open as far as the set position when pressing buttons **G** or **H**; to open it fully, press buttons **G** or **H** again.

Engine compartment lid

Opening



To unlock the engine compartment lid, pull the lever **D** underneath the steering column.

Stand in front of the vehicle, slightly lift the lid and pull the retaining lever **E** to the side of the lock and lift it.

The lid is held open by two shock absorbers.

The engine compartment lid can also be opened with the ignition key at off.



Closing

Lower the lid until it is closed and press down near the lock until you hear it click in place.

Warning



Always check manually that the engine compartment lid has been closed properly to prevent it from opening while driving.



Emergency opening of GTC4Lusso model fuel cap

1

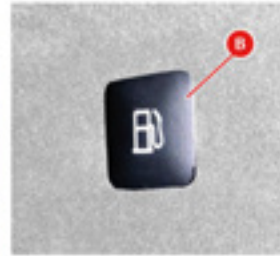



Fuel filler flap and neck

Warning



Always turn off the engine during refuelling.

Do not smoke or use naked flames when refuelling. There is a risk of fire.

The following can be harmful for your health: skin contact with petrol, inhaling petrol fumes.

Opening

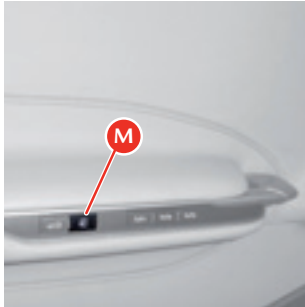

To open the fuel filler flap, press button **M** on the driver side door.

Closing

To close the fuel filler flap, push it until it clicks in place.

Emergency Opening

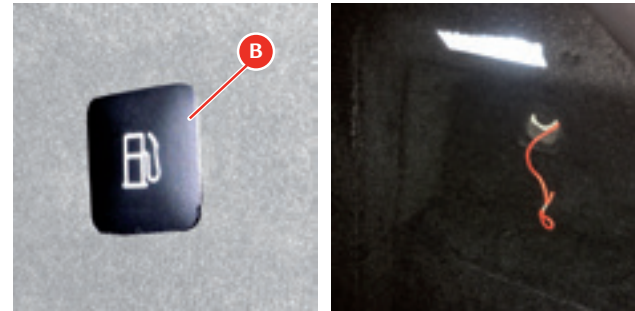

If the release button does not work, the fuel filler flap may be opened manually by pulling the cable on the right hand side of the luggage compartment: remove the panel **B** to access the cable.

Capless filler neck



This vehicle has a capless filler neck for fuelling. This system allows you to refuel by opening the fuel filler flap and simply placing the nozzle in the filler neck without having to unscrew a cap and screw it up again.



Two flaps placed in series, both with airtight seals, act as a cap. The external flap is locked by a series of “teeth” and the only way to open the external flap correctly is by inserting a petrol pump nozzle.

Warning



Place the nozzle in the filler neck carefully to avoid damaging the device seal.

Do not try to open the external flap of the filler neck by pushing it with your fingers or lever it open using unsuitable tools (e.g. screwdrivers). This may damage the external flap mechanism and the seal.

Warning



Do not overfill the fuel tank: this may cause the fuel to leak out.

After fuelling, wait for about 5 seconds before slowly removing the nozzle from the filler neck: in this way, the last drops of fuel will flow into the tank and will not drip onto the vehicle.

Warning



Do not place funnels or portable container nozzles in the filler neck.

If it is necessary to refuel from a portable fuel container, only use the funnel included in the tool kit, which releases the automatic filler neck locking mechanism.

EPB - Electric parking brake	20
Driving the vehicle.....	21



2



Moving the vehicle



EPB - Electric parking brake

On this vehicle the parking brake is actuated by an electric motor.

The parking brake can be applied and released by pulling a special lever **B** on the dashboard to the left of the steering wheel. When the instrument panel has been activated (KEY-ON), the relative warning light comes on on the instrument panel to indicate that the parking brake is engaged

To release the parking brake, pull lever **B** and keep the brake pedal pressed. If the instrument panel is activated, the warning light goes out when the parking brake has been fully released.

The electric parking brake can be used as an emergency brake when the vehicle is in motion. If this is the case, the system acts on all four wheels until button **B** is released by communicating with the ESP system which prevents locking.

Warning



Always apply the parking brake when the vehicle is parked. The vehicle should be blocked. If this is not the case, please contact the Ferrari Service Network.

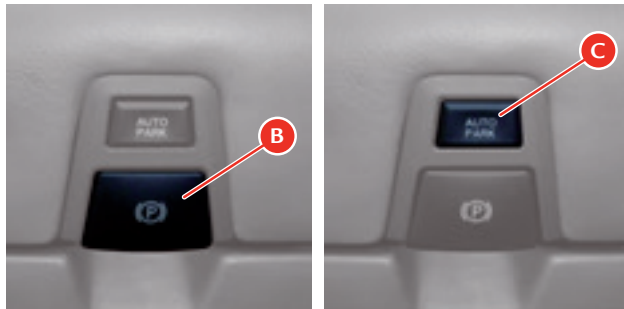

Autopark function



The EPB Autopark function automatically activates the electric parking brake when the engine is switched off. This means that the driver does not have to apply the parking brake every time the engine stops.

However, the function can be temporarily deactivated before switching off the engine by pressing the **AUTO PARK** button **C**: the message “PARK OFF” is displayed on the left TFT display for 5 seconds. In this case, after the engine is switched off, the parking brake must be engaged manually by pulling the lever **B**. To re-enable automatic EPB engagement at the next key-off, press the button **C** again; the message “PARK ON” is displayed on the left TFT display for 5 seconds.

“Automatic Vehicle Holding” AVH function

The electric parking brake provides optimised release when the vehicle starts up due to its Automatic Vehicle Holding function: once the engine has started, the system keeps the vehicle braked through intervention of the braking system rather than through the parking brake shoes.



Driving the vehicle

Running-in

The latest manufacturing techniques have allowed us to achieve high precision and accuracy levels in the construction and assembly of components. Nonetheless, the vehicle movable parts undergo a settling process, basically during the first hours of operation.

Engine and transmission

Avoid exceeding 5,000 RPM for the first 1,000 km.

After starting, do not exceed 4,000 RPM until the engine has warmed up (oil temperature: 65-70 °C).

Do not let the engine run at a constantly high speed for a prolonged time.

Warning



BEFORE YOU DRIVE

Check that the seat belts are fastened

Check that the doors are closed

Check that the seat is properly adjusted

Check the rear-view mirror adjustment (central and sides).

Before a trip

Preliminary checks

Check the following at regular intervals and always before long trips:

- tyre pressure and condition
- levels of fluids and lubricants
- condition of windscreen wiper blades
- proper functioning of the warning lights and external lights.

Important note



In any case, it is advisable to perform these checks at least every 1000 km and always comply with the maintenance schedule.

It is also advisable to:

- clean the glass covers of the external lights and all the glass surfaces
- properly adjust the mirrors, steering wheel, seats and seat belts.

Refilling

Warning



Use unleaded fuel only!

Using leaded fuel would permanently damage the catalytic converters.

For specifications and quantities of lubricants and fluids, observe the information in the "Refilling" table.

Starting and driving the vehicle

System start-up

When the instrument panel is activated (KEY-ON) both the TFT displays on the instrument panel are activated and system diagnosis is performed. During diagnosis, which lasts 5 seconds, a check is performed on the warning lights on the panel and the presence of any faults is checked.

If diagnosis detects any errors, they are only displayed once the 5 seconds required for the check have elapsed. The cases listed below are an exception and errors are displayed as soon as the key is turned on, even during diagnosis:

- Low engine oil pressure
- Inertia switch triggered



- Electronically controlled gearbox safety warnings
- EPB deactivation warning

If the next scheduled maintenance deadline is approaching, each time the key is turned to on, information on scheduled maintenance is automatically displayed after diagnosis.

Finally, each time the key is turned to on, the message for activation of the alarm when an intrusion has been attempted is also displayed (after diagnosis). Once the system check has been completed, the gearbox display is activated and the letter “P” (Parking) or “N” (Neutral) will be displayed.

Important note



BEFORE YOU DRIVE

If the gearbox warning light does not turn off after diagnosis, indicating a fault in the gearbox (which is also indicated by a symbol and specific message on the left TFT display), contact the **FERRARI SERVICE NETWORK**.

Important note



The vehicle is equipped with an electro-hydraulically controlled gearbox system operated by means of paddles on the steering wheel.

The default setting for the DCT gearbox is always “Automatic” mode.

Every time the vehicle is started, the DCT gearbox is in “Auto easy exit” mode unless the vehicle was in “Automatic” mode when the engine was turned off.

To exit the “Auto easy exit” mode, operate the UP and DOWN paddles (while the vehicle is moving) or press the AUTO button on the centre console.

Important note



Immediately release the UP and DOWN paddles or button R after the gearbox display shows that the gear has been engaged; a prolonged manoeuvre will cause the failure warning light to turn on and trigger the buzzer.

Important note



If the engine compartment lid is open or not properly closed, none of the gears can be engaged. When the vehicle is stationary, with the driver-side door open or not properly closed and the brake pedal released, the system disengages the gear engaged after approximately two seconds.

“Key-Less” ignition system

The new Ferrari keys use a Key-Less vehicle ignition system which can be used to switch on the instrument panel and the engine by simply placing the key inside the vehicle near the driving area. The dedicated ECU recognises the vehicle key by the electronic ID code it contains. The ENGINE START/STOP button on the steering wheel controls KEY-ON, KEY-OFF, ENGINE START and ENGINE STOP.

- **KEY-ON**, to activate the vehicle system (instrument panel, air conditioning and heating system, infotainment system, etc.), press and quickly release the ENGINE START/STOP button on the steering wheel.
- **KEY-OFF**, to deactivate the vehicle system without starting the engine, press the ENGINE START/STOP button on the steering wheel again.
- **ENGINE START**, to switch on the engine, press down the brake pedal and press the ENGINE START/STOP button on the steering wheel.

Important note



Hold the brake pedal down while starting the engine.

- **ENGINE STOP**, to switch off the engine when the vehicle is stationary, press the ENGINE START/STOP button on the steering wheel.

If the vehicle is in motion and the engine has to be switched off in an emergency situation, press the ENGINE START/STOP button and hold it down for at least 2 seconds (alternatively, press the button quickly 3 times in succession). If the key battery has a charge level that is only just sufficient, the vehicle informs the driver via a message on the left TFT display of the instrument panel and recommends replacing the battery as soon as possible. If the battery is flat or the key is not recognised, perform the emergency switching off procedure.

Warning



If the door closing button on the key is pressed when inside the vehicle, the engine start function is disabled. The door opening command must be given to deactivate the alarm and, in this way, the engine can be restarted. This occurs even if the door closing command is given by a key outside the vehicle when a second key is inside. The engine start function of the second key (inside the vehicle) will be disabled. By issuing the door opening command on any registered key, the engine start function is reset.

If the engine fails to start after several attempts, check for one of the following causes: insufficient starter motor speed (flat battery), faulty ignition device, faulty electrical contacts, fuel pump fuses blown.

Warming up the engine

Do not run the engine at high speed until the engine oil temperature has reached at least 65-70 °C, approximately.

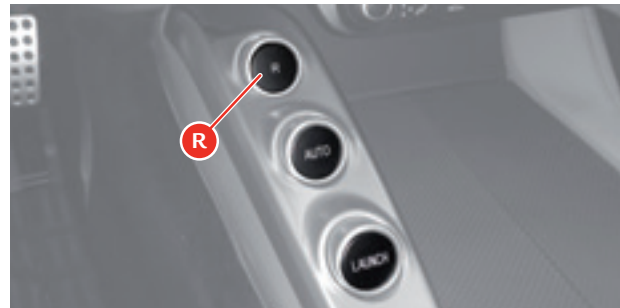

Starting the vehicle

With the engine started, the vehicle stationary and the brake pedal pressed, pull the right-hand UP paddle towards the steering wheel to engage 1st gear.

Release the brake pedal and press the accelerator to start off.

With the engine running and the vehicle stationary, you can change directly from 1st or 2nd gear to “R” (reverse) by pressing R on the centre console and from reverse to 1st by moving the UP paddle.

Warning



If the “UP” and “DOWN” paddles are not working, the message “Depress brake pedal and press LAUNCH to engage gear” will appear on the left TFT display; now press the LAUNCH button on the centre tunnel console while simultaneously depressing the brake pedal to engage the gear. In these cases, the “Launch Control” function is not available. If the engaged gear was R, the LAUNCH button must be pressed twice to engage 1st gear.



Important note



When reverse is selected, an acoustic safety signal beeps intermittently as long as “R” is engaged.

During prolonged stops with the engine running, it is advisable to keep the gearshift in “N”.

Important note



If you allow the vehicle to move forward in “N”, when “UP” or “DOWN” is requested, a gear will be engaged that corresponds to the speed of the vehicle.

UP-shifting

Use the right-hand **UP** paddle without releasing the accelerator pedal. An **UP-shift** request is not accepted when engagement of the requested gear forces the engine to underrev or if an **UP-shift** is already in progress because of engine overrevving.

UP-shifting due to overrevving

The system “automatically” engages a higher gear if the accelerator pedal is pressed and the engine approaches the “runaway speed rate” (overrevving).

Important note



This will not occur when the system is in “SPORT” and “ESC OFF” driving mode.

DOWN-shifting

Use the left-hand **DOWN** paddle without releasing the accelerator pedal. A **DOWN-shift** request is not accepted if engagement of the requested gear

forces the engine beyond a certain RPM, depending on the gear requested, or if a **DOWN-shift** is already in progress because of engine underrevving.

In any event, it is advisable to: shift gears without releasing the accelerator pedal if pressed; if **DOWN-shifting** is requested to start overtaking which requires quick acceleration, press the accelerator pedal just before using the paddle; wait until gearshifting has been completed before requesting the next shift, avoiding a rapid sequence of multiple requests.

DOWN-shifting due to underrevving

The system shifts down “automatically” if the engine goes below a minimum number of revs (1250 RPM).

Sequential downshifting

During deceleration, with the brake pedal pressed and the ABS system disabled, sequential down-shifting can be performed by holding the left-hand “**DOWN**” paddle down.

The sequential gearshifting request is accepted until the second gear is engaged.

“N” (Neutral) request

With the engine running, pull both **UP** and **DOWN** paddles towards the steering wheel at the same time without pressing the brake pedal to request neutral “N”. If necessary, “N” can be requested at any speed. Subsequently, if an “**UP**” or “**DOWN**”- shift is requested, the system will engage the gear most suited to the speed of the vehicle.

Stopping the vehicle

When the vehicle stops, the system automatically engages **1st** gear unless Neutral has already been requested. When the vehicle is stationary and the engine is running, hold the brake pedal down until ready to move off again.

Switching off the engine

The engine can be switched off with the gearbox either in “N” or with a gear engaged. After switching off the engine (ENGINE STOP), the gearbox display remains on for a few seconds and indicates which gear is engaged. If the gearbox is in “N” an acoustic alarm that lasts seconds is emitted and the message “Gearbox not in Parking position” appears on the left TFT display. Before switching off, the letter “P” is displayed on the gearbox display to inform the driver that the Park Lock has been activated.

Warning



Never leave the vehicle with the gearbox in “N”. Always make sure that the letter “P” (Parking) appears on the gearbox display. If the Park Lock system is not working properly (gearbox locked in “N” position), contact the FERRARI SERVICE NETWORK.

Warning



NEVER leave the vehicle with the engine running.

If the driver unfastens the seat belt, opens the driver-side door and walks away with the car key when the engine is still running, an alarm sounds 5 times to warn the driver that the engine must be switched off. If the engine stays running for more than 20 minutes without the brake pedal being depressed, the message “Turn OFF engine” is displayed on the left TFT display and a 30 second countdown begins. When the countdown has ended, a loud acoustic signal is emitted. Switch off the engine to stop the acoustic signal.

Warning



Never leave the vehicle with the engine running in enclosed spaces (e.g.: garage). The exhaust gases of the engine contain carbon monoxide

which is a colourless, odourless gas that can cause serious damage to health, unconsciousness, and even death.



“Automatic gearbox” mode

The “Automatic gearbox” mode is enabled/disabled by pressing the **AUTO C** button on the centre console. When the “Automatic” mode is enabled, the word “auto” appears on the gearbox display. To exit the “Automatic” mode, you must press the **AUTO** button until the word “auto” on the gearbox display disappears.

When the “Automatic Gearbox” mode is enabled, the system will automatically **UP**-shift and **DOWN**-shift according to vehicle speed, engine revs and the torque/power request of the driver.

When you are in “Automatic” mode, you can however manually shift gears using the UP and DOWN paddles. The system remains in “Automatic” mode: this is indicated by the word “auto” that remains on the gearbox display in flashing mode when the paddles are used.

When the vehicle is stationary, a “N”, 1st gear or “R” request will not result in a change from “Automatic” to “Manual”.

“Auto easy exit” mode



Every time the vehicle is started, the gearbox starts in “Auto easy exit” mode unless it was in “Automatic” mode when the engine was turned off. In this case, it remains in “Automatic” mode the next time the engine is started.

Activation is signalled by the word “auto” and an arrow in the gearbox display.

In this mode, the system will automatically UP-shift and DOWN-shift according to vehicle speed, engine revs and the torque/power request of the driver.

To exit the “Auto easy exit” mode and go to “Manual” mode, operate the **UP** or **DOWN** paddle (while the vehicle is moving) or press the **AUTO** button on the centre console.

If the “Automatic” gearbox mode is then requested by pressing the **AUTO** button, the system will apply all the characteristics of the “Automatic” gearbox mode.

Push start

Warning



Push starting is not allowed.

Safe driving

For safe driving, it is essential that the driver be aware of the best driving techniques suited to various circumstances. Always try to prevent dangerous situations by driving with caution.

Before you drive

- Adjust the position of the seat, steering wheel and rear-view mirrors, in order to obtain the best driving position.
- Adjust the backrest so that your chest is upright and your head is as close to the headrest as possible.

- Ensure that nothing (e.g. mat covers, etc.) is blocking the pedals.
- Check that the lights and headlights are working properly.
- Ensure that any child restraint systems (e.g. child seats, cradles etc.) are properly fixed on the passenger seat.
- Your reflexes are quicker if you eat lightly before driving: avoid heavy meals before a trip.
- Do not drink alcoholic drinks before and during the journey.

At regular intervals, check the following:

- Tyre pressure and condition.
- Engine oil level.
- Engine coolant level and system condition.
- Brake fluid level.
- Steering fluid level.
- Windscreen washer fluid level.

While travelling

- Caution is the number one rule for safe driving which also means you should take other people’s behaviour into consideration.
- Follow the Road Regulations in force in the country you are driving in and always respect the speed limit.
- Always make sure that the driver and passengers have their seat belts fastened and that all children are travelling in suitable child seats.
- Good personal physical conditions ensure you can drive long distances safely.

Warning



Driving under the influence of drugs, some medicines and alcohol is dangerous to yourself and others as well as contravening road regulations and legal norms.



Travelling without your seat belt fastened increases the risk of serious injury and death in the event of a collision. Always fasten seat belts and use child seats, if present.

Do not travel with objects lying on the floor, especially in front of the driver's seat: in the event of braking, these could slide under the pedals, making it impossible to brake or accelerate.

Additionally, ensure that any loose floor mats sit correctly.

Water, ice and salt spread on icy roads may deposit on the brake discs and reduce the efficiency of the initial braking.

- Make regular stops to loosen up your limbs and refresh yourself, and avoid driving for hours on end.
- Keep air circulation constant in the passenger compartment.
- Never coast downhill with the engine off: in these conditions the engine brake, servo brake and power steering are inefficient, braking requires greater pressure on the pedal and steering will be harder.

Driving at night

When you are travelling at night, follow these fundamental rules:

- Reduce speed, particularly on dark roads.
- Driving conditions are more demanding at night, so take particular care.
- If you start feeling tired or sleepy, stop immediately: to continue driving would be a risk for yourself and for others. Continue only after you have had a rest.
- At night, it is difficult to judge the speed of vehicles in front of you as you can only see their tail lights: keep at a greater safety distance than you would during the day.
- Use the high beams only outside of urban areas and when you are sure that they will not disturb other drivers.

- Turn off the high beams when you see oncoming vehicles and use the low beams.
- Keep lights and headlights clean.
- Watch out for animals crossing the road when travelling outside urban areas.

Driving in the rain

Rain and wet roads can cause hazardous situations.

Warning



Given the vehicle's reduced ground clearance, a characteristic that guarantees exceptional aerodynamic performance and driving comfort, in adverse weather conditions we recommended driving through standing water or floods as slowly as possible. This recommendation should be observed to prevent water entering the intake ducts and causing irreparable damage to the engine.

All manoeuvres are more difficult on a wet road since tyres have significantly less grip on the road. This means that the braking distances increase considerably and road-holding decreases.

Here is some advice for driving in the rain:

- Slow down.
- Keep a greater safety distance between yourself and the other vehicles and reduce your speed.
- When it is raining very hard, visibility is also reduced. In these cases, to make yourself more visible to others, turn on the low beams even during the day.
- Drive through puddles at low speed to avoid losing control of the vehicle ("aquaplaning"): if this occurs, grip the steering wheel firmly.



Warning



If the road is wet, reduce your speed to avoid “aquaplaning” (when the tyre no longer touches the road surface because the side channels of the tyre tread are not capable of removing all the channelled water due to their particular shape or insufficient depth and a layer of water is placed between the road surface and the tyre. The fluid pressure generated is so high that it supports the vehicle's weight making it virtually impossible for the driver to control the vehicle).

- Use the air conditioning and heating system to demist the windscreen and avoid visibility problems.
- Periodically check the condition of the windscreen wiper blades.

Driving in fog

Whenever possible, avoid travelling if there is thick fog. If you have to drive in misty conditions, or if there is thick fog or fog banks, follow these rules:

- Keep a moderate speed.
- Turn on the low beams, also during the day, and use the rear fog light. Avoid using the high beams.

Warning



On stretches where visibility is good, turn off the rear fog light, it may be annoying for the occupants of the vehicles behind you.

- Remember that fog makes the road damp and therefore all manoeuvres are more difficult and braking distances are longer.
- Keep a safe distance from the vehicle in front of you.
- Avoid suddenly changing speed and direction as far as possible.

- Avoid overtaking as far as possible.
- In the event of an emergency stop, (e.g. failures, inability to proceed due to poor visibility conditions, etc.) try to free the main driving lane. Then turn on the hazard warning lights and, if possible, the low beams. On approaching another vehicle, sound the horn rhythmically.

Driving on mountain roads

Below is some advice for driving on steep mountain roads:

- To prevent the brakes from overheating when driving downhill, use the engine to brake by engaging a lower gear.
- Never coast downhill or drive downhill with the engine off or in neutral, nor with the ignition key removed from the steering column.
- Drive at a moderate speed and do not “cut” corners.
- Remember that overtaking uphill is slower and requires a longer free stretch of road. If you are overtaken when driving uphill, ensure that the other vehicle can pass easily.

Driving on snowy or icy roads

Below is some advice for driving in these conditions:

- Keep a very moderate speed.
- Keep a safe distance from the vehicles in front of you.
- Fit snow tyres approved for the vehicle.
- Given the poor grip, use the engine brake as much as possible and avoid sudden braking.
- Avoid sudden acceleration and sharp changes in direction.
- During the winter season, even apparently dry roads can have icy sections.

Therefore, be careful when driving along stretches of road in the shade as there may be icy patches.



Driving with the “ABS” braking system

The ABS system assists the driver as follows:

- It prevents the wheels from locking and skidding during emergency braking, particularly in low-grip conditions.
- It allows braking and changing direction at the same time. This feature is affected by the physical limits and lateral grip of the tyres.
- When the ABS is activated, you will feel a slight pulsing of the brake pedal during emergency braking or in low-grip conditions. DO NOT release the pedal but continue to push it to give continuity to the braking action.
- The ABS prevents the wheels from locking, but it does not increase the physical limits of grip between the tyres and the road: keep a safe distance from the vehicles in front and reduce speed before curves.

Power steering system

The power steering system uses the power produced by the engine to help the driver steer more precisely while exerting less force on the steering wheel.

Important note



Remember that power steering does not work when the engine is switched off and more force is therefore needed when steering.

Warning



Do not keep the steering wheel fully turned (locked position) to the right or the left for more than 15 seconds when the engine is running. This may damage the power steering system.

Important note



If the power steering system is not working properly, as indicated by a symbol which appears on the left TFT display, contact the FERRARI SERVICE NETWORK.

2

Suspension damping control

This vehicle uses latest generation MagneRide™ magnetorheological suspension, a system perfected by FERRARI for continuous automatic damping control.

By processing data received from the vehicle dynamics sensors and sensors that detect bodyshell movements, the ECU interprets the driving conditions and the road surface and immediately adjusts suspension response by varying the control current of each shock absorber.

These sensors allow the ECU to calculate the vehicle speed, vertical and lateral acceleration, steering angle and instantaneous pressure in the braking system, and hence to control suspension damping.

This system not only ensures an optimal compromise between racing-style performance (handling) and comfort, but is capable of emphasising either aspect by using the different adjustments available controlled by the “Manettino” driving mode control switch. Three different setting levels are available on this vehicle.

Level 1 (ICE)

Setting optimised to obtain the best traction in low-grip conditions, for example on snow or ice (Manettino set to ICE).

Level 2 (COMFORT)

Slightly more rigid setting, optimised to better absorb road unevenness and provide a better grip on wet road surfaces (Manettino set to WET and COMFORT).

Level 3 (SPORT)



Even more rigid setting optimised for sports-style driving and high speed (in medium-high grip conditions or on the race track) without significantly affecting comfort (Manettino set to SPORT and ESC OFF).

Driving using the driving mode control switch (“Manettino”)

The driving mode control switch on the steering wheel allows the driver to use the vehicle potential in a fast and intuitive way.

There are five modes available, which correspond to the grip level (from low to high) and consequently to the level of driving assistance required (from high to none).

ICE mode

In “ICE” mode, performance is optimised to obtain maximum stability which is essential for use in very low-grip conditions (snow or ice). Suspension damping is optimised to provide the best possible absorption and traction on snow or ice (Level 1); the ESC system is at its maximum level.

If “ICE” mode is selected, it is indicated on the left TFT display as shown below:

WET mode

“WET” mode ensures stability on dry as well as on wet roads. It is therefore recommended for low grip conditions (e.g. rain) and on slippery or extremely uneven roads, but also to enhance comfort during city driving. Suspension damping is optimised to provide the best possible absorption (Level 2); the ESC system switches to Level 2.

If “WET” mode is selected, it is indicated on the left TFT display as shown below:

COMFORT mode

The “COMFORT” mode offers an optimal compromise between performance and comfort and is recommended for everyday driving in

medium-high grip conditions. Suspension damping remains at the same level as the previous setting whereas the ESC system switches to Level 3.

If “COMFORT” mode is selected, it is indicated on the left TFT display as shown below:

SPORT mode

“SPORT” mode is for sports-style driving in high-grip conditions. This mode is designed to ensure stability only in medium-high grip conditions. Suspension damping shifts to Level 3 and gearshifting is more racy. The ESC system also switches to a different level offering you greater driving freedom. If “SPORT” mode is selected, it is indicated on the left TFT display as shown below:

ESC OFF mode

In “ESC OFF” mode the ESC system is disabled. No electronic systems other than the E-Diff and the 4WD system control vehicle stability and the driver is allowed complete freedom and control of the vehicle for track use.

Warning



In low- to medium-grip conditions (e.g. wet, icy, sandy roads), do not deactivate the ESC system.

Important note



When “ESC OFF” mode is selected, the Manettino lever automatically goes back to “SPORT” mode: this occurs because each time the engine is started, the ESC system is reactivated.



Important note



When the brake pedal is pressed, traction control is activated via the VDC system (vehicle dynamics control via the braking system).

If “ESC OFF” mode is selected, this is indicated on the left TFT display as shown below:

Warning



Test-driving the vehicle occasionally on the race track: after each start, cover the first straight stretch of the track (at least 500 meters) at a constant speed so that the traction control system and the ABS may calculate exactly the grip available and the diameter of the tyres (the calculation is reset every time the engine stops).

If this rule is not followed, system performance may be reduced.

Dimensions and weights	34
Position of tool bag in GTC4Lusso model	36
Toolkit	37
Emergency tyre repair and inflation kit	37
Replacing a wheel	39
Towing	41
Emergency release of the electric parking brake (EPB) ..	42
Park Lock emergency release	43
Towing with wheel axle raised	44
Loading the vehicle onto the trailer	44
Securing the vehicle to the trailer	45



Towing the vehicle



Dimensions and weights

Wheelbase	2990 mm
Max. length	4922 mm
Max. width (with mirrors folded out)	2063 mm
Max. width (excluding mirrors)	1980 mm
Front track	1674 mm
Rear track	1668 mm
Kerb weight*	1920 kg
Dry weight*	1790 kg

* considering the most favourable Optional combination



3



Position of tool bag in GTC4Lusso model



Toolkit

Tool kit

Stored in the luggage compartment, it contains the necessary tools for emergency repair jobs:

- pair of cotton gloves;
- set of fuses;
- pliers for removing fuses;
- tow hook;
- insulated cutting pliers;
- funnel for emergency fuelling;
- screwdriver for slotted and crosshead screws;
- EPB emergency release tool;
- Park Lock emergency release tool;
- emergency tyre repair and inflation kit.

Warning



Repair work using the toolkit requires:

- suitable protective equipment (e.g. gloves)
- adequate precautions to be taken (e.g. during tyre replacement never lie under a vehicle raised by a jack)
- minimum specific expertise when working in contact with electrical parts/components (e.g. battery).



3

Warning



The Electric Parking Brake (EPB) emergency release tool and the Park Lock emergency release tool may only be used by specialised workshop technicians, as indicated on the label on the tool kit.

Emergency tyre repair and inflation kit

Stored in the luggage compartment, it can be used in the event of a puncture or low tyre pressure to repair and/or inflate a tyre enough to continue the journey safely.

Important note



To use the tyre repair and inflation kit correctly, refer to the instruction booklet supplied with the kit.

Warning



Give the instruction booklet supplied with the kit to the personnel that will have to deal with the tyre treated with the tyre repair kit.



Warning



If damaged by foreign objects, tyres with cuts of up to 4 mm in diameter on the tyre tread and shoulder can be repaired.

Warning



Punctures cannot be repaired on the sides of the tyre. Do not use the tyre repair kit if the tyre has been damaged after driving with a flat tyre.

Warning



Damage to the wheel that causes air leaks cannot be repaired. Do not remove foreign objects (screws or nails) that have penetrated the tyre.

Warning



After using the repair kit, the vehicle must however be considered to be in an emergency situation: drive with the greatest care (maximum speed allowed 80 km/h - 50 mph).

Warning



Apply the sticker supplied with the kit where it can easily be seen by the driver to indicate that the tyre has been treated with the tyre repair kit. Drive carefully especially on bends. Avoid sudden accelerating or braking.

Warning



The kit should be used to temporarily repair only one tyre punctured by foreign objects with a limited diameter: the kit may not be useful for large punctures or tears.

Important note



After driving for approximately 10 minutes, stop and recheck the tyre pressure. Remember to use the parking brake.

Warning



Do not continue driving if the pressure has dropped below 1.8 bar: the kit cannot guarantee the correct grip because the tyre is too damaged. Contact the Ferrari Service Network.

If the tyre pressure is at least 1.8 bar, pump the tyre up to the correct pressure and continue driving. Drive very carefully to the nearest Ferrari Service Network.

Warning



The repaired tyre must be replaced as soon as possible and the workshop personnel must be informed that the tyre was treated with tyre repair fluid.

Warning



Keep the kit in its box and out of children's reach.

Do not inhale or swallow the fluid contained in the cartridge and avoid contact with the skin and eyes.



Warning



The spray contains ethylene glycol and latex.

Latex may cause an allergic reaction, is harmful if swallowed and is irritating to the eyes. May cause sensitisation by inhalation and skin contact. Avoid contact with eyes, skin and clothing. In case of contact, rinse immediately with plenty of water. If swallowed, do not induce vomiting, rinse mouth, drink plenty of water and seek immediate medical advice. Keep out of reach of children. The product should not be used by asthma sufferers. Do not inhale vapours during use. In the event of an allergic reaction, seek immediate medical advice. Store the spray can in its special case away from sources of heat.

The liquid sealant has an expiry date: the expiry date is indicated on the kit.

Environment



Replace the spray can containing the expired liquid sealant. Do not dispose of the spray can and liquid sealant in normal domestic waste. Dispose of in accordance with national and local regulations or ask the Ferrari Service Network to take care of disposal.

Warning



The sealant in the kit cartridge can damage the sensor inside the wheels on vehicles fitted with a tyre temperature and pressure monitoring system (TPMS). If this occurs, the sensor must be replaced. Contact the Ferrari Service Network.

Warning



Wear the protective gloves supplied with the tyre repair and inflation kit.

Useful accessories

In addition to the tools supplied with the vehicle, a hazard warning triangle and high visibility safety vest must always be kept on board in order to warn other motorists of danger in compliance with the legislation in force.

Replacing a wheel

Important note



If one or more wheels need to be replaced, proceed as follows:

- replace the wheel stud bolts with damaged threads or tapers
- carefully clean the wheel stud bolts before fitting
- do not lubricate the contact surfaces between the stud bolt and the wheel rim and between the wheel rim and the brake disk.

In order not to remove the antilock coating, do not clean the wheel rim cones with solvents or aggressive products.

collapsible spare wheel (in the countries where available)

On request, the vehicle comes with a kit containing:

- collapsible spare wheel **A** with space-saving tyre; label **B** indicates the maximum speed allowed of 80 km/h.
- additional tool bag **C** containing the jack for raising the vehicle and the socket wrenches for operating the jack and tightening the wheel stud bolts.

3



Warning



The spare wheel must only be used for short trips in the event of an emergency. When the spare wheel is fitted, never exceed the maximum speed of 80 km/h and drive carefully, especially around bends and when overtaking, avoiding sudden acceleration or braking. Do not exceed the approved weight limits. Do not fit snow chains on the spare wheel. Never fit more than one spare wheel at a time.

Important note



Failure to comply with these instructions could lead to loss of control of the vehicle and consequently damage to the vehicle and injuries to its occupants.

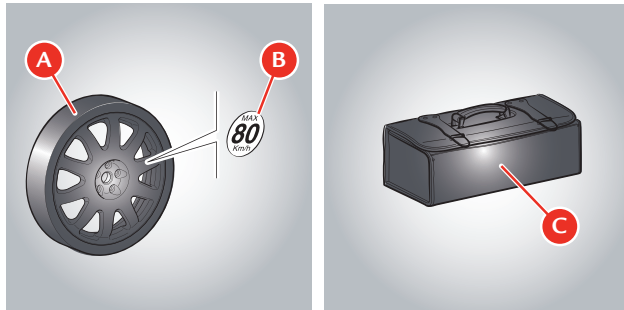

Replacing a wheel

- Position the vehicle on an even surface, then block the rear wheels by applying the parking brake.

Warning



Make sure that the vehicle is in a safe position by applying the parking brake.

- If necessary, switch on the hazard warning lights and place the hazard triangle at the required distance from the vehicle.
- Take the spare wheel and tools out of the luggage compartment.

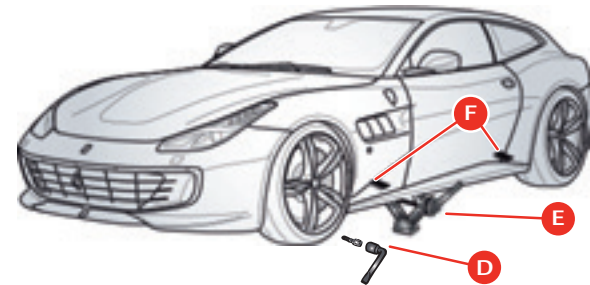

- Loosen the five wheel stud bolts approximately one turn each using wrench **D** supplied.
- Place the base of the jack **E** on flat firm ground under one of the jacking points **F** on the underfloor as shown in the figure.
- Raise the vehicle carefully using jack **E** until the wheel is off the ground.



Warning



Before replacing one or more wheels, make sure no one is in the vehicle.

If the jack is not positioned correctly, the vehicle could slip off. Make sure that no part of the body is underneath the vehicle while changing the wheel. The supplied jack must only be used for changing wheels.

- Unscrew the five stud bolts and remove the wheel.
- Fit the uninflated collapsible spare wheel.
- Screw the stud bolts into place but do not tighten them.

Important note



Inflate the collapsible spare wheel before lowering the vehicle to avoid damaging the rims.

- Inflate the collapsible spare wheel using the inflation kit.

Important note



The kit must be used in “tyre inflation” mode. Refer to the instruction manual supplied with the kit.

- Inflate the spare wheel to the indicated pressure.
- Lower the vehicle and remove the jack.
- Tightly fasten the stud bolts, alternately going from one stud bolt to one that is diametrically opposite.

As soon as possible, tighten the stud bolts with the torque wrench to a torque of 100 Nm.

Towing

When towing the vehicle, avoid using anchor points that are not designed for the tow hook inserted in housing **B**.

Proceed as follows:

- Take the tow hook out of the tool bag;
- Tightly screw the tow hook into housing **B**;
- Release the EPB;
- Release the Park Lock.

Warning



If there is an electrical system failure, release the EPB and Park Lock manually.

Warning



While towing the vehicle, you must comply with Road Regulations.

Warning



Do not tow the vehicle by attaching to levers, suspension and wheel rims but only to the tow hook properly fitted in place.

Keep the instrument panel activated to enable the lights to work; when towing the vehicle, do not start the engine.

Important note



Remember that when the engine is switched off, the power steering and brake servo functions do not work.

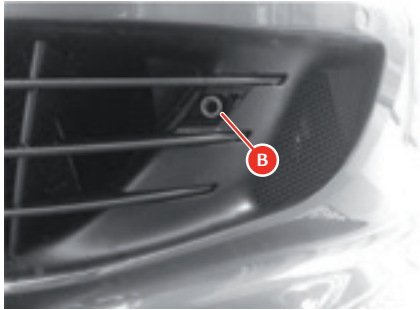

Emergency release of the electric parking brake (EPB)

Warning



The release procedure must only be carried out by specialised workshop technicians.

If the system cannot be released, contact the nearest Ferrari Service Centre.

Warning



When the electric parking brake is deactivated manually, the vehicle may move. To keep the vehicle stationary, the Park Lock safety device must be applied: make sure that the letter “P” appears on the gearbox display.

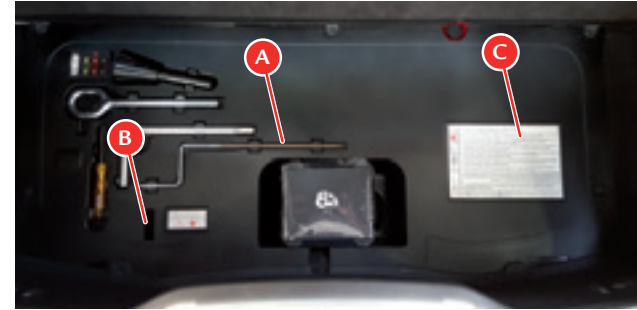

If the vehicle needs to be moved but the electric parking brake cannot be deactivated because the battery is flat or there is a failure in the electrical system that controls it, the emergency release procedure described below must be performed.

- Take wrench **A** for EPB emergency release out of the tool bag.

Warning



Wrench **A** may only be used by specialised workshop technicians, as indicated on label **C** on the tool kit.

- Using the special rectangular slot **B** on the LH side of the tool kit (indicated by a label), place the wrench in the EPB release housing (in the lower part of the slot, as shown in the figure) and turn it clockwise: this loosens the parking brake cables.

Important note



To release the brake completely, the wrench needs to be turned 50 times and it starts to be released after approximately 20 turns.

Once the electric parking brake has been manually released, the EPB node records a failure at the next key-on and a special symbol and the following message are displayed on the left TFT display: “Parking Brake system revision. Go to dealer”.

Warning



The parking brake resumes normal operation, but it is important to go to the nearest workshop to have it calibrated and delete any errors in the error memory. Go to a FERRARI SERVICE CENTRE. Calibration is necessary for safety reasons.

Park Lock emergency release

Warning



The emergency release procedure must only be carried out by specialised workshop technicians. If the system cannot be released, contact the nearest FERRARI SERVICE CENTRE.

Warning



This should be avoided unless absolutely necessary:

- to tow the vehicle;
- if there is a Park Lock failure (displayed on the left TFT display with the message “Only manual unlock gearbox allowed: See handbook”).

Warning



When the Park Lock safety device is deactivated manually, the vehicle may move unexpectedly. The vehicle is only kept stationary by the parking brake, if applied.

The Park Lock manual emergency release device is found in the top right of the tool kit, as shown by the arrow in the figure.

To perform the Park Lock emergency release procedure, do the following:

- Take wrench **D** out of the tool kit.

Warning



Wrench **D** may only be used by specialised workshop technicians, as indicated on label **C** on the tool bag.

- Remove the rubber protection cap **E**.
- Place wrench **D** in the manual release device housing **F**.
- To perform the emergency release, turn wrench **D** clockwise for a quarter turn.

If the electrical system allows it, check that the letter “N” appears on the gearbox display by activating the instrument panel. The following message will appear on the left TFT display: “Gearbox not in Parking position”. At the same time, an audible signal is repeated four times to indicate that it has been released.



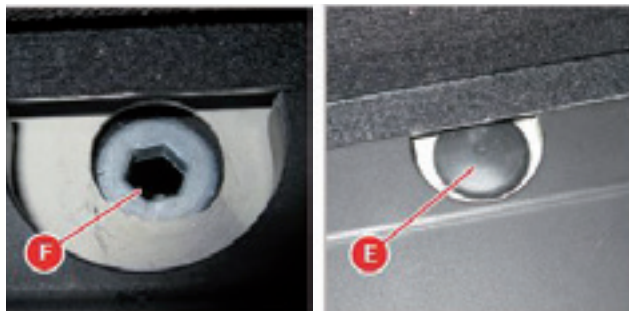

Towing with wheel axle raised

This must only be performed by skilled staff. The raised wheel axle must always be the rear one. Make sure that the front wheels are in a straight line and the steering lock is engaged.

Loading the vehicle onto the trailer

- Manually release the Park Lock.

Important note



If possible, use the Carwash procedure.

- Release the electric parking brake (EPB).

Warning



DO NOT pull the vehicle onto the trailer using the wheel spokes as anchors to avoid damaging the wheels.

Warning



DO NOT attach the straps to the suspension or parts of the bodyshell.

- Attach the winch cable to the tow hook to lift the vehicle onto the trailer.

Warning



DO NOT attach the winch cable to other parts of the vehicle.

Warning



DO NOT pull the vehicle onto the trailer using only the tow hook but lift it using the special straps.



Warning



Avoid using excessive force on the tow hook when lifting and pulling the vehicle onto the trailer.

- The use of ramps or wooden planks may be necessary if there is limited space in front of or behind the vehicle.

Securing the vehicle to the trailer

- Secure the vehicle to the trailer using the wheels and the most suitable device for ensuring it is correctly secured as anchors.

Warning



DO NOT attach the straps to the suspension or parts of the bodyshell.

- Once the vehicle has been secured to the trailer, remove the key.